

SAFETY PRECAUTIONS



The lightning flash with arrowhead symbol, within an equilateral triangle, is intended to alert the user to the presence of uninsulated “dangerous voltage” within the product’s enclosure that may be of sufficient magnitude to constitute a risk of electric shock to persons.



The exclamation point within an equilateral triangle is intended to alert the user to the presence of important operating and maintenance (servicing) instructions in the literature accompanying the appliance.

WARNING: TO REDUCE THE RISK OF FIRE OR ELECTRIC SHOCK, DO NOT EXPOSE THIS APPLIANCE TO RAIN OR MOISTURE. DANGEROUS HIGH VOLTAGES ARE PRESENT INSIDE THE ENCLOSURE. DO NOT OPEN THE CABINET. REFER SERVICING TO QUALIFIED PERSONNEL ONLY.

WARNING: Handling the cord on this product or cords associated with accessories sold with this product, will expose you to lead, a chemical known to the State of California to cause birth defects or other reproductive harm. ***Wash hands after handling.***

WARNING: This [product] contains mercury. Disposal of mercury may be regulated due to environmental considerations. For disposal or recycling information, please contact your local authorities or the Electronic Industries Alliance: www.eiae.org.

MODEL NAME: TDP-P8 **USA only**

TRADE NAME: DATA PROJECTOR

MODEL NAME: TDP-P8



Tested To Comply
With FCC Standards

FOR HOME OR OFFICE USE

FCC NOTICE: This device complies with part 15 of the FCC Rules. Operation is subject to the following two conditions:

(1) This device may not cause harmful interference, and (2) this device must accept any interference received, including interference that may cause undesired operation. This equipment has been tested and found to comply with the limits for a Class B digital device, pursuant to part 15 of the FCC Rules. These limits are designed to provide reasonable protection against harmful interference in a residential installation. This equipment generates, uses and can radiate radio frequency energy and, if not installed and used in accordance with the instructions, may cause harmful interference to radio communications. However, there is no guarantee that interference will not occur in a particular installation. If this equipment does cause harmful interference to radio or television reception, which can be determined by turning the equipment off and on, the user is encouraged to try to correct the interference by one or more of the following measures:

-
- Reorient or relocate the receiving antenna.
 - Increase the separation between the equipment and receiver.
 - Connect the equipment into an outlet on a circuit different from that to which the receiver is connected.
 - Consult the dealer or an experienced radio/TV technician for help.

RESPONSIBLE PARTY: TOSHIBA AMERICA INFORMATION SYSTEMS, INC.
9740 Irvine Blvd., Irvine, CA 92618-1697 U.S.A
Phone: (949) 583-3000

WARNING: Changes or modifications made to this equipment, not expressly approved by **USA only** Toshiba, or parties authorized by Toshiba, could void the user's authority to operate the equipment.

WARNING: This Class B digital apparatus complies with Canadian ICES-003. Cet appareil numérique de la classe B est conforme à la norme NMB-003 du Canada.

IMPORTANT SAFETY INSTRUCTIONS

CAUTION: PLEASE READ AND OBSERVE ALL WARNINGS AND INSTRUCTIONS GIVEN IN THIS OWNER'S MANUAL AND THOSE MARKED ON THE UNIT. RETAIN THIS BOOKLET FOR FUTURE REFERENCE.

This set has been designed and manufactured to assure personal safety. Improper use can result in electric shock or fire hazard. The safeguards incorporated in this unit will protect you if you observe the following procedures for installation, use and servicing. This unit is fully transistorized and does not contain any parts that can be repaired by the user.

DO NOT REMOVE THE CABINET COVER, OR YOU MAY BE EXPOSED TO DANGEROUS VOLTAGE. REFER SERVICING TO QUALIFIED SERVICE PERSONNEL ONLY.

1. Read Owner's Manual

After unpacking this product, read the owner's manual carefully, and follow all the operating and other instructions.



2. Power Sources

This product should be operated only from the type of power source indicated on the marking label. If you are not sure of the type of power supply to your home, consult your product dealer or local power company. For products intended to operate from battery power, or other sources, refer to the operating instructions.



3. Source of Light

Do not look into the lens while the lamp is on. The strong light from the lamp may cause damage to your eyes or sight.



4. Ventilation

Openings in the cabinet are provided for ventilation and to ensure reliable operation of the product and to protect it from overheating, and these openings must not be blocked or covered. The openings should never be blocked by placing the product on a bed, sofa, rug or other similar surface. This product should not be placed in a built-in installation such as a bookcase or rack unless proper ventilation is provided or the manufacturer's instructions have been adhered to.



5. Heat

The product should be situated away from heat sources such as radiators, heat registers, stoves, or other products (including amplifiers) that produce heat.

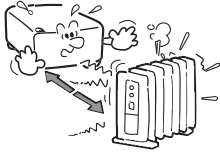

6. Water and Moisture

Do not use this product near water. - for example, near a bath tub, wash bowl, kitchen sink, or laundry tub; in a wet basement; or near a swimming pool and the like.



7. Cleaning

Unplug this product from the wall outlet before cleaning. Do not use liquid cleaners or aerosol cleaners. Use a soft cloth for cleaning.

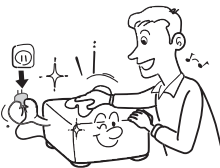

8. Power-Cord Protection

Power-supply cords should be routed so that they are not likely to be walked on or pinched by items placed upon or against them, paying particular attention to cords at plugs, convenience receptacles, and the point where they exit from the product.



9. Overloading

Do not overload wall outlets; extension cords, or integral convenience receptacles as this can result in a risk of fire or electric shock.



IMPORTANT SAFETY INSTRUCTIONS (Continued)

10. Lightning storms

For added protection for this product during storm, or when it is left unattended and unused for long periods of time, unplug it from the wall outlet. This will prevent damage to the product due to lightning and power-line surges. However, while it is thundering or lightning, do not touch the apparatus and any connected cable and/or equipment. This will prevent you from receiving the electric shock by an electric surge.

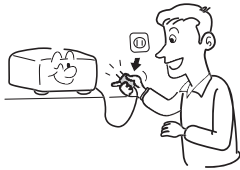

11. Object and Liquid Entry

Never push objects of any kind into this product through openings as they may touch dangerous voltage points or short-out parts that could result in a fire or electric shock. Never spill liquid of any kind on the product.



12. Do not place the product vertically

Do not use the product in the upright position to project the pictures at the ceiling, or any other vertical positions. It may fall down and dangerous.

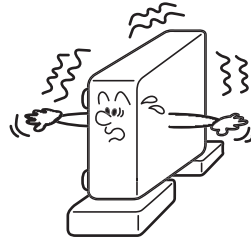

13. Stack Inhibited

Do not stack other equipment on this product or do not place this product on the other equipment. Top and bottom plates of this product develops heat and may give some undesirable damage to other unit.



14. Attachments

Do not use attachments not recommended by the product manufacturer as they may cause hazards.

15. Accessories

Do not place this product on an unstable cart, stand, tripod, bracket, or table. The product may fall, causing serious injury to a child or adult, and serious damage to the product. A product and cart combination should be moved with care. Quick stops, excessive force, and uneven surfaces may cause the product and cart combination to overturn.



16. Damage Requiring Service

Unplug this product from the wall outlet and refer servicing to qualified service personnel under the following conditions:

- a) When the power-supply cord or plug is damaged.
- b) If liquid has been spilled, or objects have fallen into the product.
- c) If the product has been exposed to rain or water.
- d) If the product does not operate normally by following the operating instructions. Adjust only those controls that are covered by the operating instructions as an improper adjustment of other controls may result in damage and will often require extensive work by a qualified technician to restore the product to its normal operation.

- e) If the product has been dropped or damaged in any way.
- f) When the product exhibits a distinct change in performance - this indicates a need for service.

17. If glass components, including lens and lamp, should break, contact your dealer for repair service.

This product incorporates glass components, including a lens and a lamp. If such parts should break, please handle with care to avoid injury and contact your dealer for repair service. The broken pieces of glass may cause injury. In the unlikely event of the lamp rupturing, thoroughly clean the area around the projector and discard any edible items placed in that area.

18. Servicing

Do not attempt to service this product yourself as opening or removing covers may expose you to dangerous voltage or other hazards. Refer all servicing to qualified service personnel.



IMPORTANT SAFETY INSTRUCTIONS (Continued)

19. Replacement Parts

When replacement parts are required, be sure the service technician has used replacement parts specified by the manufacturer or have the same characteristics as the original part. Unauthorized substitutions may result in fire, electric shock, or other hazards. (Replacement of the lamp only should be made by users.)

20. Safety Check

Upon completion of any service or repairs to this product, ask the service technician to perform safety checks to determine that the product is in proper operating condition.



21. Do not leave thermal paper documents or easily deformed items on top of the unit or near the air exhaust for long periods of time.

The heat from the unit could erase the information on the thermal paper, or cause deformation or warping.

22. Do not use the product in a closed installation state.

Do not place the product in a box or in any other closed installation state. Otherwise it may overheat. This could result in a risk of fire.

23. Do not look into the laser light source of the remote control or direct the laser pointer toward a person or a mirror.

The laser beam may cause damage to the eyes or sight.

POWER SUPPLY CORD SELECTION

If your line voltage is 220 to 240V, use one of the following types of cable.

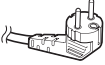
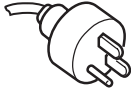
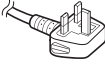
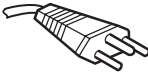
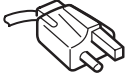
Plug configuration	Plug type	Line voltage	Plug configuration	Plug type	Line voltage
	EURO	220 – 240V		Australian 240V 10A	200 – 240V
	UK	220 – 240V		Switzerland 240V 6A	200 – 240V
Use a 5A fuse which is approved by ASTA or BSI to BSI362. Always replace the fuse cover after changing the fuse.				North American 240V 15A	200 – 240V

IMPORTANT PRECAUTIONS

Save Original Packing Materials

The original shipping carton and packing materials will come in handy if you ever have to ship your projector. For maximum protection, repack the set as it was originally packed at the factory.

Moisture Condensation

Never operate this unit immediately after moving it from a cold location to a warm location. When the unit is exposed to such a change in temperature, moisture may condense on the lens and the crucial internal parts. To prevent the unit from possible damage, do not use the unit for at least 2 hours when there is an extreme or sudden change in temperature.

Place and Manner of Installation

- Do not place in hot locations, such as near heating equipment. Doing so could cause malfunction, and shorten the life of the projector.
- Avoid locations with oil or cigarette smoke. Doing so will dirty the optical parts, shortening their lives, and darkening the screen.
- Do not use this product in the upright position or tilt it up or down by more than 20° from level. Doing so may cause a failure or shorten the life of the product.
- Using this instrument near a TV or radio may cause interference to the images or audio sound. If this happens, move it away from the TV or radio.
- Moving the projector from a low-temperature room to a high-temperature room may cause condensation on the lens or internal parts in the instrument. If you continue to use it in that situation, the malfunction may result. Ensure to wait until the condensation naturally disappears.
- In a high altitude location where air is thin, cooling efficiency is reduced so use the projector with **[Fan mode]** set to **[High]**.

IMPORTANT PRECAUTIONS (Continued)

- The set of projector is hot after use. Handle with care.
- Do not use the projector while holding it in your hands or lap.
- Do not use the projector near a power source and the like, or in locations like a ship or vehicle that are subject to vibration or shock. Doing so may lead to a malfunction or shorten service life.

Avoid Volatile Liquid

Do not use volatile liquids, such as an insect spray, near the unit. Do not leave rubber or plastic products touching the unit for a long time. They will leave marks on the finish. If cleaning with a chemically saturated cloth, be sure to follow the product's precautions.

EXEMPTION CLAUSES

- Toshiba Corporation bears no responsibility in the case of damages arising from natural disaster such as earthquakes, lightning, etc., fire not liable to Toshiba Corporation, acts by third parties, other accidents, or use under abnormal conditions including erroneous or improper operation and other problems.
- Toshiba Corporation bears no responsibility for incidental damages (lost profit, work interruption, corruption or loss of the memory contents, etc.) arising from the use of or the inability to use this unit.
- Toshiba Corporation accepts no liability whatsoever for any damages arising from not having followed the descriptions in this Instruction Manual.
- Toshiba Corporation accepts no liability whatsoever for any damages arising from malfunctions arising from combination with equipment or software that is not related to Toshiba Corporation.

In the spaces provided below, record the Model and Serial No. located at the bottom of your projector.

Model No. _____ Serial No. _____

Retain this information for future reference.

OTHER CAUTIONS AND INFORMATIONS

Copyrights

Showing or transmitting commercial imaging software or broadcast or cable-broad casting programs with the purpose of other than the personal and private viewing, including modifying images using the freeze, resize, PIP, or SPLIT screen functions, or displaying with the varying aspect ratio of the images, could violate the direct or indirect copyrights of the imaging software or broadcast program, etc., if done without first consulting with the copyright holder. For this reason, please take appropriate measures before performing one of the actions listed above, including obtaining a license from the copyright holder.

Disposal

Following information is only for EU-member states:

The use of the symbol indicates that this product may not be treated as household waste. By ensuring this product is disposed of correctly, you will help prevent potential negative consequences for the environment and human health, which could otherwise be caused by inappropriate waste handling of this product. For more detailed information about recycling of this product, please contact your local city office, your household waste disposal service or the shop where you purchased the product.



This product contains substances which are harmful to humans and the environment.

- The lamp contains inorganic mercury.
Please dispose of this product or used lamps in accordance with local regulations.

Trademarks

- VGA, SVGA, XGA, SXGA, UXGA are trademarks or registered trademarks of International Business Machines Corporation.
- Digital Light Processing, Digital Micromirror Device and DMD are trademarks of Texas Instruments.
- Macintosh is a registered trademark of Apple Computer, Inc.
- Windows is a registered trademark of Microsoft Corporation in the U.S. and other countries.
- Adobe is a registered trademark and Acrobat Reader is a trademark of Adobe Systems Incorporated.

Notational Conventions Used in This Manual

- References to pages with related information are annotated as follows.
For example, if making a reference to page 35:
- The illustrations in this document are for reference purposes only and may not reflect your package exactly.

REMOTE CONTROL BATTERIES

Caution

- Never throw batteries into a fire.

Notes

- Be sure to use AAA size batteries.
- Dispose of batteries in a designated disposal area.
- Attention should be drawn to the environmental aspects of battery disposal.
- Do not mix different battery types or combine used batteries with new ones.
- If the remote control does not operate correctly, or if the operating range becomes reduced, replace both batteries with new ones.
- If the batteries are dead or if you will not be using the remote control for a long time, remove the batteries to prevent battery acid from leaking into the battery compartment.

Using the batteries improperly may cause them to explode or leak and lead to burn or injury. If battery-leaking fluid contacts skin, wash the fluid off immediately with clean water and consult a doctor. If the fluid is spilt on an instrument, avoid contact and wipe it off using tissue paper.

(Dispose of the used tissue paper as flammable garbage after moistening with water.)

Table of Contents

Table of Contents	13
Introduction	14
Package Overview	14
Product Overview	15
Main Unit.....	15
Control Panel	16
Connection Ports	17
User Controls	18
Control Panel & Remote Control	18
Preparing and using the remote control	20
Operating a computer using the remote control	22
Installation	23
Connecting the Projector.....	23
Turning the power on and off	24
Connecting the power cord	24
Removing the lens cover	24
Turning the power on Press the ON / STANDBY button	24
Turning the power off.....	25
Adjusting the Projected Image	26
Adjusting the Projector Image Height	26
Adjusting the Projector Zoom / Focus.....	27
Adjusting Projection Image Size	27
Adjusting the screen size and focus	28
Using the menus	29
How to use the menus.....	29
The image adjustment menu.....	30
The display setting menu	31
The default setting menu	32
Manual adjustments and settings.....	33
Displaying Information (Status display)	34
Appendices	35
Trouble shooting.....	35
Replacing the lamp.....	38
Computer Compatibility (Analog)	40
Specifications	41
About Lamp.....	42
About Lamp	42
Immediately replace the lamp when a sign appears on the screen	42
When the lamp is broken.....	42
Lamp replacement.....	43
Lens cleaning	43
Main unit cleaning	43

Introduction

Package Overview

This projector comes with all the items shown below. Check to make sure your unit is complete. Contact your dealer immediately if anything is missing.



Projector with lens cap



Power Cord 3m



VGA Cable 3m



USB Cable 3m



Remote mouse Control
with Laser Pointer



Owner's Guide



- ❖ The shape and number of supplied power cords vary depending on the product destination.



AAA battery for mouse
remote control(2)



Carrying Case



Owner's Manual

◆The Supplied CD-ROM

The supplied CD-ROM contains an owner's manual, including information not available for the printed Owner's manual (Getting started) and Acrobat® Reader™ to view the manual.

■ Installing Acrobat® Reader™

Windows®: Run the CD-ROM, select the **Reader/English** folder, and run **ar500enu.exe**. Follow the on-screen instructions.

Macintosh: Run the CD-ROM, select the **Reader/English** folder, and run **Reader Installer**. Follow the on-screen instructions to install the software.

■ Viewing the manual

Run the CD-ROM and double-click on **Start.pdf**. Acrobat® Reader™ launches, and the menu screen of the Owner's manual appears. Click on your language. The Owner's Manual cover appear.

Introduction (Continued)

Product Overview

Main Unit



1. Control Panel (See page 16 for detailed information.)
2. Zoom Lever
3. Focus Ring
4. Projection lens
5. Lens Cap
6. Foot adjuster
7. Front foot adjuster release button
8. Infrared remote sensor
9. Rear panel (Connection external devices.)
10. AC IN socket

Introduction (Continued)

Control Panel

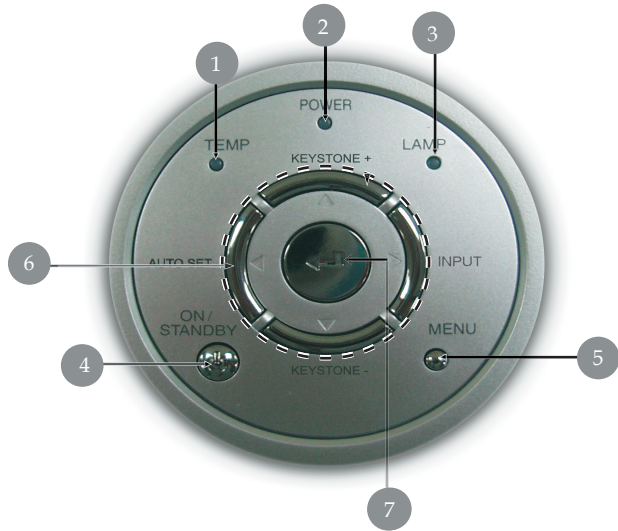

1. Temp Indicator LED (Refer to page 37 for more information.)
2. On indicator light(Refer to page 37 for more information.)
3. LAMP indicator(Refer to page 37 for more information.)
Indicates the status of the lamp has developed a problem.
4. ON/STANDBY button (Refer to page 24 for more information.)
Turns the projector on or off.
5. MENU button Open,saves and exits the on-screen menu.
6. ▲ , ▼ , ◀ , ▶ , button The directional buttons are used to select the desired menu items and to make adjustments when the onscreen menu is activated. Refer to page 18 for more information.
7. ENTER button : Accepts the selected mode.

Introduction (Continued)

Connection Ports

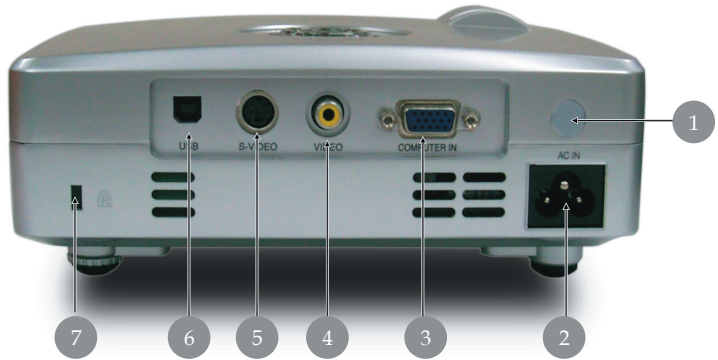

1. Infrared remote sensor
2. AC IN socket(Connect the supplied power cord here.)
3. COMPUTER (Y/PB/PR) IN terminal
RGB : Input analog RGB signal from a computer or other source, or a component video signal (Y/PB/PR) from video equipment.
4. Video IN terminal
5. S-Video IN terminal
6. USB terminal (for remote mouse control)
7. Antitheft lock hole
(Attach a safety cable or any other antitheft device.)

❖ ***The projector is a moveable equipment***

User Controls

Control Panel & Remote Control

There are two ways for you to control the functions: Remote Control and Control Panel.

Control Panel



Remote Control



Using the Control Panel

On / Standby

- ▶ Refer to the “Power On/Off the Projector” section on page 24.

Input

- ▶ Press “Input” to choose RGB, Component-p, Component-i, S-Video, Composite Video and HDTV sources.

Menu

- ▶ Press “Menu” to launch the on screen display (OSD) menu. To exit OSD, press “Menu” again.

Keystone +/- /

- ▶ Adjusts image distortion caused by tilting the projector (± 15 degrees).

Enter

- ▶ Confirm your selection of items.

Auto Set

- ▶ Automatically synchronizes the projector to the input source.

User Controls (Continued)

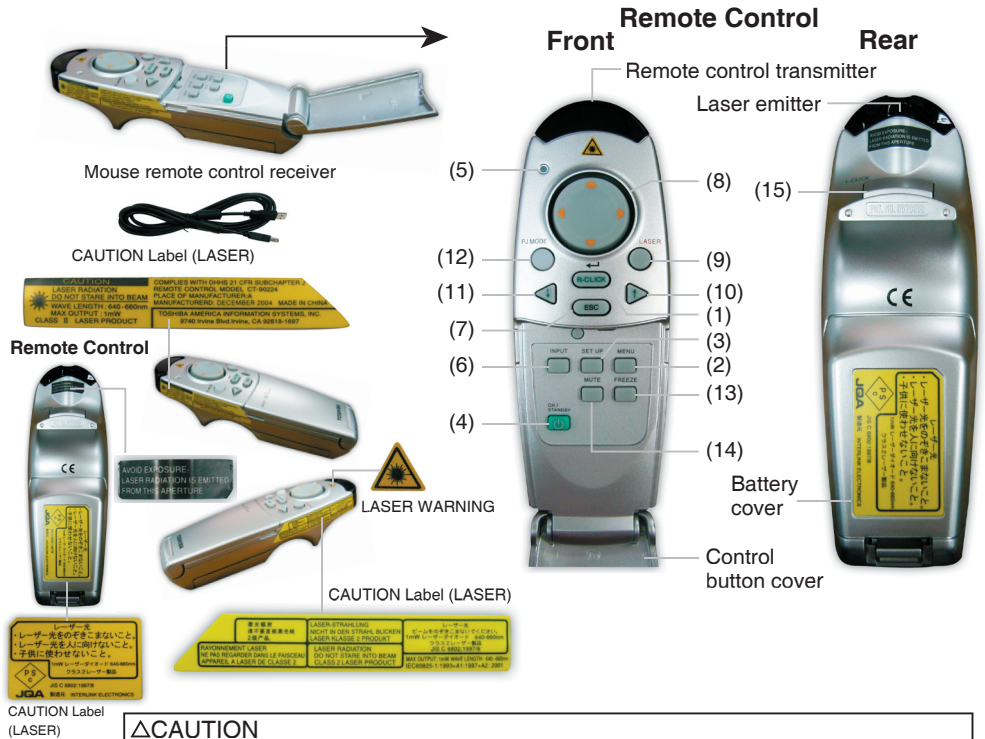

△CAUTION

- Do not look into the laser light source of the remote control or direct the laser pointer toward a person or a mirror.
- Handling and adjusting other than described here may lead to dangerous exposure to laser.

- | | |
|----------------------------|--|
| Name | : Main Function |
| (1) ENTER button | : Accepts the selected mode. |
| (2) MENU button | : Displays menus. |
| (3) Set up | : Set up image and mode. |
| (4) ON/STANDBY button | : Turns the power on/off (standby). |
| (5) Transmission indicator | : Lights when remote control transmitting. |
| (6) INPUT button | : Selects input. |
| (7) ESC | : Quit the current screen. |
| (8) Selection button | : Menu selections and adjustments, etc. |
| (9) LASER button | : Displays laser point. |
| (10) ▸ button | : This control functions as a computer's ▸ button. |
| (11) ◀ button | : This control functions as a computer's ◀ button. |
| (12) PJ MODE button | : Switches remote control mode. |
| (13) FREEZE button | : Pauses image. |
| (14) MUTE button | : Cuts off the picture. |
| (15) L-CLICK button | : Left button click of remote control mouse. |

User Controls (Continued)

Preparing and using the remote control

■ Loading dry-cell batteries into the remote control

1. Remove the battery cover.

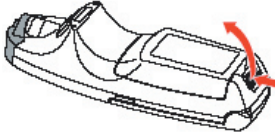

2. Insert the dry-cell batteries.

Be sure to align the plus and minus ends of the batteries properly.

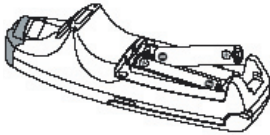

3. Replace the battery cover.

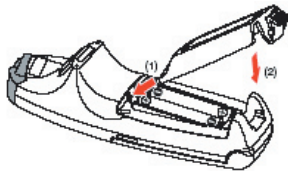

■ Dry-cell batteries

- Remove batteries from remote control when not using for extended periods.
- If the remote control stops working, or if its range decreases, replace all the batteries with new ones.

■ The remote control

- The remote control may fail to operate if the infrared remote sensor is exposed to bright sunlight or fluorescent lighting.
- Do not drop or bang.
- Do not leave in hot or humid locations.
- Do not get wet or place on top of wet objects.
- Do not take apart.
- In rare cases, ambient conditions could impede the operation of the remote control. If this happens, point the remote control at the main unit again, and repeat the operation.

■ Operating the remote control

Point the remote control toward the projector's infrared remote sensor, and press a button on the remote control.

- Operating the projector from the front

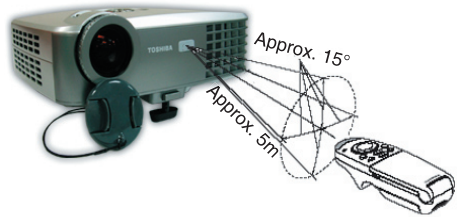

- Operating the projector from the rear



User Controls (Continued)

Preparing and using the remote control (Continued)

■ Switching operation mode

Operation modes should be switched between projector operation and computer operation.

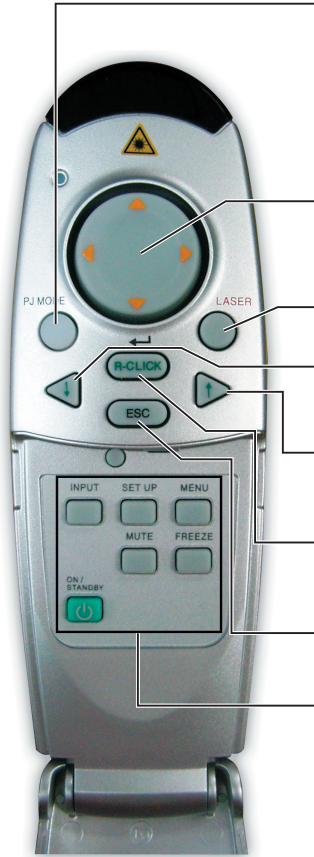

Switching the remote control operation mode. Pressing this button toggles the mode. When this button is lit, the remote control is in [PJ Mode] (Projector operation mode). If no operations are made for 30 seconds, this light goes out, and the remote switches back to [PC Mode] (Computer operation mode).

[PJ Mode] : Functions as a select button. If no menu is displayed, operate "INPUT", "KEYSTONE", "AUTO SET" button

[PC Mode] : Functions as a mouse pointer control.

Pressing displays a laser pointer, regardless of the mode.

[PC Mode] : Functions as a down button. Used to go forward on Microsoft® PowerPoint® slides, etc.

[PC Mode] : Functions as an up button. Used to go back on Microsoft® PowerPoint® slides, etc.

[PC Mode] : Functions as the right mouse button (R-CLICK).

[PC Mode] : Functions as a ESC button.

Pressing one of these buttons automatically sets the remote control to [PJ Mode]. If no operations are made for 30 seconds, and the remote switches back to [PC Mode].

The L-CLICK (left click) button on the back of the remote control functions when in [PC Mode].

■ Notes

- With the exception of operating a PC with the remote control, all buttons are used in [PJ Mode].
- Make sure there is nothing between the remote control and the IR sensor on the projector that might obstruct the infrared beam.

User Controls (Continued)

Operating a computer using the remote control

A computer can be operated using the projector's remote control. This function is available on any computer with the Windows 98/98SE, Windows Me, Windows 2000, or Windows XP OS, that is equipped with a USB port supporting the USB 1.1 (The mouse remote control is supported on OS 9 or OS X for the Macintosh). The operation cannot be guaranteed for all the environments of computers.

1 Connecting a computer

Connect the supplied USB cable to the computer.

2 Operating a computer

The mouse remote control function is available when the remote control is set to [PC Mode]. (See "Switching operation modes".) Point the Mouse remote control at the mouse remote control receiver, and operate the remote control's buttons.

- **Moving the mouse pointer**

Move the pointer control button in the direction that you wish the mouse pointer to move, then press.

- **To left click**

Press the L-CLICK button.

- **To right click**

Press the R-CLICK button.

- **To drag and drop**

Move the pointer control button in a (L-)clicked state, then when the pointer is over the desired location, release the button.

- **Using the computer's up and down arrow key functions**

Press the ◀ and ▶ buttons to switch PowerPoint® slides.

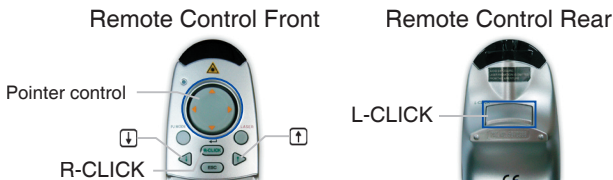

Installation

Connecting the Projector

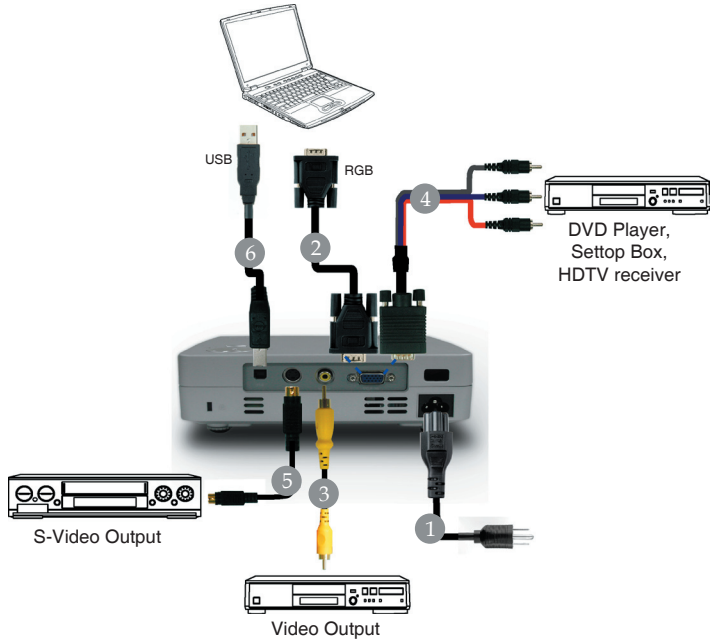

❖ Due to the difference in applications for each country, some regions may have different accessories.

- | | |
|---------|---------------------------------------|
| 1. | Power Cord |
| 2. | VGA Cable |
| 3. | Video Cable(not supplied) |
| 4. | D-sub15p to YPbPr cable(not supplied) |
| 5. | S-VIDEO cable(not supplied) |
| 6. | USB cable |

❖ *To ensure the projector works well with your computer, please set the display mode of your graphic card less than or equal to 1024 X 768 resolution. Make sure the timing of the display mode is compatible with the projector. Refer to the “Compatibility Modes” section on page 40.*

Installation (Continued)

Turning the power on and off

■ Connecting the power cord

- 1 Insert the power cord connector into the AC IN socket of the projector.
- 2 Insert the power cord plug into a wall or other power outlet.



■ Removing the lens cover



Be sure to remove the lens cover when the power is turned on. If it is left on, it could become deformed due to heat.

■ Turning the power on

Press the **ON/STANDBY** button.

The power turns on, and green indicators light: POWER.
After a moment, the start-up screen appears.

Control panel



Remote Control



Start-up screen

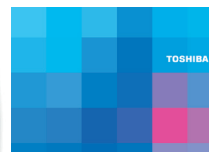

⚠ CAUTION

- Do not look into the lens while the lamp is on. The strong light from the lamp may cause damage to your eyes or sight.
- Do not block the air intake or exhaust. Doing so could cause a fire due to internal overheating.
- Do not place your hands, face, or other objects near the air exhaust. Doing so could cause burns, deform/break the object.

■ Notes

- The start-up screen will disappear after a moment. You can dismiss the start-up screen before this by performing any operation. You can also configure the start-up screen not to appear via the **Display setting** menu.

Installation (Continued)

- The first time you use the projector after purchase, after the start-up screen, please press “MENU” button.

■ Turning the power off

1 Press the ON/STANDBY button.

A message appears on the screen, confirming that you wish to shut off the power. This message will disappear after a moment. (This operation is no longer valid after the message disappears.)

2 Press the ON/STANDBY button again.

If the screen turns off, but the internal cooling fan continues to operate for a short while. Then, the projector goes into standby mode.

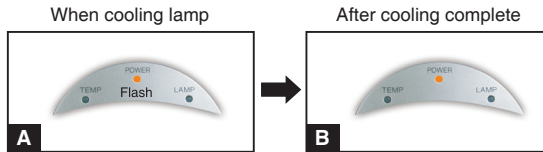

- A** During cooling, the POWER indicator flashes. In this state, the power cannot be turned back on. If you are in a hurry, there is no problem with unplugging the power cord or turning off the power consumption in this state.
- B** In standby mode.

■ Note

- The projector consumes about 3-4W of power in standby. We recommend that you unplug the power cord or turn off the main power switch if you will not be using the projector for an extended period.

■ PRECAUTION

- If the power cord is unplugged before cooling is complete, give the lamp time (about 5 minutes) to cool before plugging it back in. If the lamp overheats, it may fail to light.

Installation (Continued)

Adjusting the Projected Image

Adjusting the Projector Image Height

The projector is equipped with an elevator foot for adjusting the image height.

To raise the image:

1. Press the foot adjuster button ❶.
2. Raise the image to the desired height angle ❷, then release the button to lock the foot adjuster into position.
3. Use ❸ to fine-tune the display angle.

To lower the image:

1. Press the foot adjuster button.
2. Lower the image, then release the button to lock the foot adjuster into position.
3. Use ❸ to fine-tune the display angle.

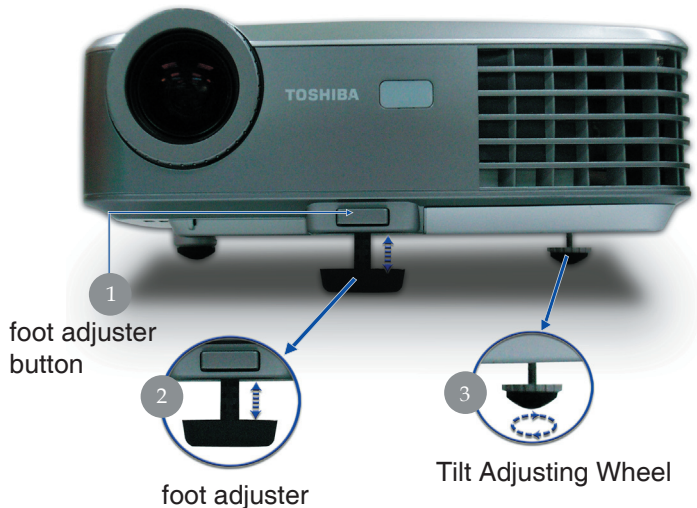

Installation (Continued)

Adjusting the Projector Zoom / Focus

You may turn the zoom lever to zoom in or out. To focus the image, rotate the focus ring until the image is clear. The projector will focus at distances from 5 to 40 feet (1.5 to 12.2 meters).

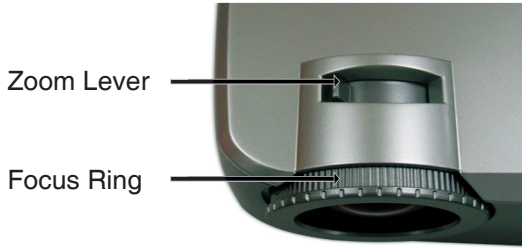

Adjusting Projection Image Size

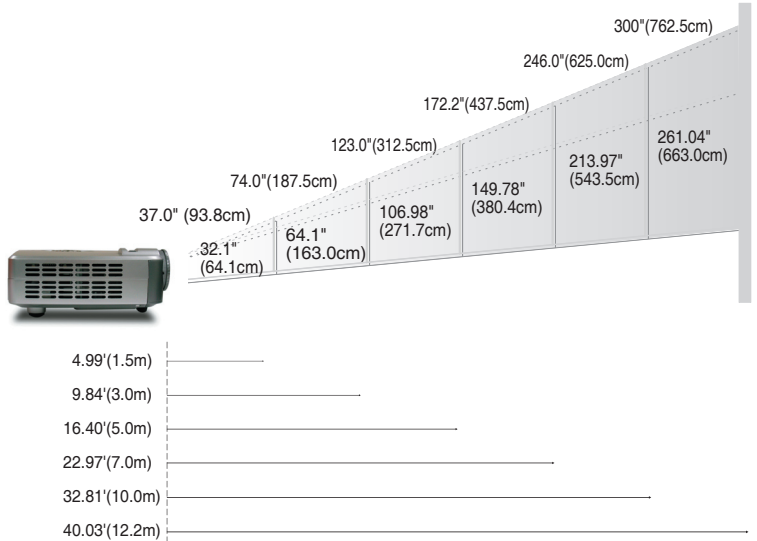

Screen (Diagonal)	Max.	37.0" (93.8cm)	74.0" (187.5cm)	123.0" (312.5cm)	172.2" (437.5cm)	246.0" (625.0cm)	300.0" (762.5cm)
	Min.	32.10" (81.5cm)	64.19" (163.0cm)	106.98" (271.7cm)	149.78" (380.4cm)	213.97" (543.5cm)	261.04" (663.0cm)
Screen Size	Max.(WxH)	29.50" x 25.60" (75.0 x 62.5cm)	59.06" x 44.29" (150.0 x 112.5cm)	98.43" x 73.82" (250.0 x 187.5cm)	137.80" x 103.35" (350.0 x 262.5cm)	196.85" x 147.64" (500.0 x 375.0cm)	240.16" x 180.12" (610.0 x 457.5cm)
	Min.(WxH)	25.66" x 19.26" (65.2 x 48.9cm)	51.35" x 38.51" (130.4 x 97.8cm)	85.59" x 64.19" (217.4 x 163.0cm)	119.82" x 89.87" (304.3 x 228.3cm)	171.17" x 128.38" (434.8 x 326.1cm)	208.83" x 156.62" (530.4 x 397.8cm)
Distance		4.99'(1.5m)	9.84'(3.0m)	16.40'(5.0m)	22.97'(7.0m)	32.81'(10.0m)	40.03'(12.2m)

❖ This graph is for user's reference only.

Notes

- No ceiling mount installation.

Installation (Continued)

Adjusting the screen size and focus

- ① Use the zooming lever to adjust the screen size.
- ② Use the focusing lever to adjust the focus.

Notes

- Note that a lamp characteristics may rarely cause the brightness to fluctuate slightly.
- A lamp is consumable item. If used for extended periods, images will appear dark, and the lamp could burn out. This is characteristic of a lamp, and is not malfunction. (The lifetime of the lamp depends on conditions of use.)
- The DMD™ is made using extremely advanced technology, but there may be black spots (pixels that do not light) or bright spots (pixels that are constantly lit) on the panel. Please note that these are not malfunctions.
- Although this projector supports a wide range of RGB signals, any resolutions not supported by this projector (XGA) will be expanded or shrunk, which will affect image quality slightly. To view high-quality images, it is recommended that the computer's external output should be set to XGA resolution.
- With some models of computer having LCD displays or the like, displaying images simultaneously on the projector and the monitor's display may prevent the images from displaying properly. If this happens, turn off the computer's LCD display. For information on how to turn off the LCD display, see the owner's manual of your computer.
- If no signal is being input from the connected equipment or signal input is stopped while projecting, the "No signal" will appear.
- If a signal not supported by the projector is input, the "Unsupport signal" will appear.
- If an unavailable operation button is pressed, the  icon will appear.



Using the menus

You can call up on-screen menus, and conduct a number of adjustments and settings using the operation buttons on the control panel (main unit side) and remote control.

How to use the menus





The menu shown below is for operation instructions purposes and might differ from the actual display.

1. Press the MENU button Display the **Setting display** menu.

2. Select a Category

Select a category by using ◀ ▶.

There are following five categories:

-  **Image adjustment** menu
-  **Display setting** menu
-  **Default setting** menu
-  **Set up** menu
-  **Status display** menu



Displays the current adjustments and settings of selected category. Item shown with gray cannot be adjusted with the current input source.

3. Adjustments & Settings

Press ⏻ to open the menu.

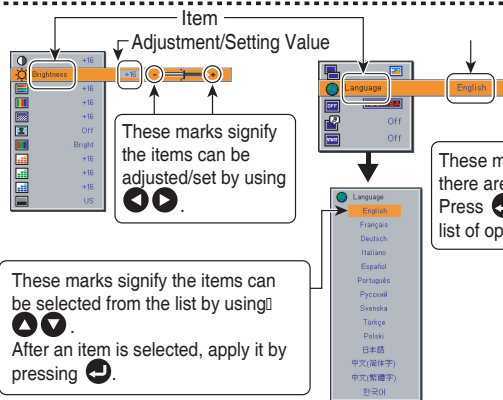

Item

Adjustment/Setting Value

These marks signify the items can be adjusted/set by using ◀ ▶.

These marks signify the items can be selected from the list by using ▲ ▼.

After an item is selected, apply it by pressing ⏻.

These marks signify that there are options. Press ⏻ to display a list of options.

The figure shows displays given for operation instructions purposes. As the display may differ depending on the item, use the following pages as a reference.

5. End
Press the MENU button
The menu disappears.





































4. Back
MENU button

Using the menu (Continued)

■ The image adjustment menu

Use this menu to adjust image-related items.

Items that can be adjusted are marked with “Yes”, and those that cannot are marked with “No”.



















Item  	Description	Computer	Y/P _B /P _R	Video S-video
 Contrast	Adjust the image contrast. Lower   Higher	Yes	Yes	Yes
 Brightness	Adjust the brightness of the image. Darker   Brighter	Yes	Yes	Yes
 Color	Adjust the color of the image. Lighter   Deeper	No	Yes	Yes
 Tint *1	Adjust the tint of the image color. Reddish   Greenish	No	No	Yes
 Sharpness	Adjust the sharpness of the image. Softer   Sharper	No	Yes	Yes
 Noise reduction	Set the function to reduce screen noise. On (Enable)   Off (Disable)	No	Yes	Yes
 Picture mode	Press  . Toggle the picture mode with  /  .	Yes	No	No
 R-level	Adjust red of the image color. Less red   More red	Yes	Yes	Yes
 G-level	Adjust green of the image color. Less green   More green	Yes	Yes	Yes
 B-level	Adjust blue of the image color. Less blue   More blue	Yes	Yes	Yes
 NTSC mode *1	Set the black level with  /  button. US: NTSC (US) mode Japan: NTSC (JAPAN) mode	No	No	Yes

*1: [Tint] and [NTSC mode] can be displayed and adjusted only when the video signal is set to [NTSC] and [NTSC4.43]. (NTSC mode is set to JAPAN when the language is set to Japanese. It is set to US for other languages.)

Using the menu (Continued)

■ The display setting menu

Use this menu to set screen display-related items.

Item ▲▼	Description
 Screen size	  (Full): Display with 1024 × 768 dot resolution  (Thru): Display with sampling resolution (for computer input)  (Wide): Wide-screen display (for Video, S-video, and Y/P _B /P _R)
 Language	Select one of the languages below to use for displaying the menu and messages [ : Enter setting mode] → [ : Selection] → [Apply: ] English/Français/Deutsch/Italiano/Español/Português/Русский /Svenska/Türkçe/Polски/日本語/中文(簡体字)/中文(繁体字)/한국어
 Background	Screen to display when there is no input signal (Logo)   (Blue)  (Black)
 Icon	Display icons as function guides On   Off
 Start-up screen	Display start-up screen when power is turned on On   Off



















■ Note

- If “Thru” is selected for **screen size**, portions exceeding the native resolution (1024 × 768 pixels) will not appear on the screen. Note that for RGB signals with clock frequency 140MHz or lower, all input pixel signals are sampled. However, if the clock speed is higher than this, the RGB pixel signal is thinned before sampling.
- If you use the screen size setting function on commercial video software, broadcast or cable-broadcasting programs to display images with the varying aspect ratio except for the purpose of your private viewing and listening, it may infringe the copyright protected by the copyright laws.

Using the menu (Continued)

■ The default setting menu

This menu shows placement status and other settings.

Item ▲ ▼	Description
 Projection mode	Sets projection mode in accordance with Placement Style.  Standard : The factory default setting.  Rear-Desktop : When you select this function, the projector reverses the image so you can project behind a translucent screen.
 No signal power off	Set the timer to wait for the power to be turned off after signal input stops. Press  . Switch with ▲ and ▼. Off (not turned off)/ 1 min./5 min./10 min./30 min./60 min.
 Auto input search	Set whether the input with signals is only selected or not. On   Off
 Lamp power ^[Note 1]	Sets the lamp power. Low   Standard
 Fan mode ^[Note 2]	Sets the cooling fan speed. Standard   High
 Reset all	Press  . Resets all adjustments and settings to their factory settings. Yes   No







Notes





















- 1: When **Lamp power** is set to **Low**, the screen becomes a little darker, but the cooling fan noise gets quieter.
- 2: Setting [**Fan mode**] to [**High**] increases the cooling fan speed. Set this option to use the projector, for example, at high altitude (over 1,500 meters above sea level).

Using the menu (Continued)

● Manual adjustments and settings

The menu items of the Set up menu vary depending on the input type, as shown in the table below.

Use the      buttons to adjust the items in the table below, then press the  button when you are finished.

Select Item  	Description	Computer	Y/P _B /P _R	Video S-video
 Auto. Keystone	Automatically corrects the keystone distortion. Press  .	Yes	Yes	Yes
 Keystone	Correct the keystone (trapezoid) distortion of the screen. Screen shrinking   Screen shrinking downward upward	Yes	Yes	Yes
 Auto setting	Automatically adjusts items such as the sampling phase depending on the type of input signal. Press the MENU button.	Yes	No	No
 Phase	Adjust with   to eliminate flicker.	Yes	No	No
 Frequency	Adjust with   to eliminate periodic patterns and flickering when many vertical lines appear on the screen.	Yes	No	No
 H-position	Adjust the horizontal position of the image. Move left   Move right	Yes	No	No
 V-position	Adjust the vertical position of the image. Move down   Move up	Yes	No	No

Using the menu (Continued)

■ Displaying Information (Status display)

This displays information about the input signal, lamp use time, etc.

“Yes”: displayed, “No”: not displayed

Item	Description	Computer	Y/P _B /P _R	Video S-video
Input	Input source name	Yes	Yes	Yes
Mode name	RGB input mode ^[Note 1]	Yes	No	No
H-resolution	Horizontal resolution (in dots)	Yes	No	No
V-resolution	Vertical resolution (in dots)	Yes	No	No
H-frequency	Horizontal sync frequency	Yes	No	No
V-frequency	Vertical sync frequency ^[Note 2]	Yes	No	No
Sync	Sync signal polarity ^[Note 3]	Yes	No	No
Signal format	Y/P _B /P _R signal format	No	Yes	No
Video mode	Color method of video signal	No	No	Yes
Lamp time	Time of lamp use ^[Note 4]	Yes	Yes	Yes
Lamp reset count	The count for lamp replacement	Yes	Yes	Yes
Total time	The total time that this projector is used	Yes	Yes	Yes
Version	Firmware version ^[Note 5]	Yes	Yes	Yes

Notes

- 1: The mode of supported RGB signals p.39 is shown.
- 2: Same as the refresh rate of the computer signal.
- 3: Sync signal polarity shown as P (positive) or N (negative) for [H/V].
- 4: Displays [**Lamp time**] as a measure of when the lamp should be replaced. (Cannot be used as a counter of guaranteed lamp time.) When the displayed time approaches 2,000 hours, consult with a store about getting a TLPLP8 replacement lamp (sold separately) prepared.
- 5: [**Version**] shows the version of the projector's internal control program. This version is referred to for customer service, etc.

■ Note

- The displayed information will not be refreshed if the status changes. To refresh the information, dismiss the display, then display it again.

Trouble shooting

If you experience trouble with the projector, refer to the following information. If the problem persists, please contact your local reseller or service center.

Problem : No image appears on screen.

- ▶ Ensure all the cables and power connections are correctly and securely connected as described in the “Installation” section.
- ▶ Ensure the pins of connectors are not crooked or broken.
- ▶ Check if the projection lamp has been securely installed. Please refer to the “Replacing the lamp” section.
- ▶ Make sure you have removed the lens cap and the projector is switched on.

Problem : Partial, scrolling or incorrectly displayed image.

- ▶ Press “PJ Mode” on the Remote Control or press “AUTO SET” on the Control Panel.
- ▶ If you are using a PC:

For Windows 3.x:

1. In the Windows Program Manager, double click the “Windows Setup” icon in the Main group.
2. Verify that your display resolution setting is less than or equal to 1280 x 1024.

For Windows 95, 98, 2000, XP:

1. From the “My Computer” icon, open the “Control Panel” folder, and double click the “Display” icon.
2. Select the “Settings” tab
3. Click on the “Advanced Properties” button.

If the projector is still not projecting the whole image, you will also need to change the monitor display you are using. Refer to the following steps.

Appendices (Continued)

4. Verify the resolution setting is less than or equal to 1280 x 1024 resolution.
 5. Select the “Change” button under the “Monitor” tab .
 6. Click on “Show all devices.” Next, select “Standard monitor types” under the SP box; choose the resolution mode you need under the “Models” box.
- ▶ If you are using a Notebook:
1. First, follow the steps above to adjust resolution of the computer.
 2. Press the toggle output settings. example:[Fn]+[F4]

Compaq=>	[Fn]+[F4]	Hewlett	[Fn]+[F4]
Dell =>	[Fn]+[F8]	Packard=>	[Fn]+[F4]
Gateway=>	[Fn]+[F4]	NEC=>	[Fn]+[F3]
IBM=>	[Fn]+[F7]	Toshiba =>	[Fn]+[F5]
<hr/>			
Mac Apple:			
System Preference-->Display-->Arrangement-->Mirror display			

- ▶ If you experience difficulty changing resolutions or your monitor freezes, restart all equipment including the projector.

Problem : The screen of the Notebook or PowerBook computer is not displaying a presentation.

- ▶ If you are using a Notebook PC:

Some Notebook PCs may deactivate their own screens when a second display device is in use. Each has a different way to be reactivated. Refer to your computer’s documentation for detailed information.

Problem : Image is unstable or flickering

- ▶ Use “Phase” to correct it. Refer to page 33.
- ▶ Change the monitor color setting from your computer.

Problem : Image has vertical flickering bar

- ▶ Use “Frequency” to make an adjustment. Refer to page 33.
- ▶ Check and reconfigure the display mode of your graphic card to make it compatible with the product.

Appendices (Continued)

Problem : Image is out of focus

- ▶ Adjusts the Focus Ring on the projector lens. Refer to page 27.
- ▶ Make sure the projection screen is between the required distance 5 to 40 feet (1.5 to 12.2 meters) from the projector.

Problem : The image is stretched when displaying 16: 9 DVD.

The projector automatically detects 16:9 DVD and adjusts the aspect ratio by digitizing to full screen with 4:3 default setting.

If the image is still stretched, you will also need to adjust the aspect ratio by referring to the following:

- ▶ Please select 4:3 aspect ratio type on your DVD player if you are playing a 16:9 DVD.
- ▶ If you can't select 4:3 aspect ratio type on your DVD player, please select 4:3 aspect ratio in the on screen menu.

Problem : Image is reversed.

- ▶ Select "Default setting" from the OSD and adjust the projection direction. See page 32.

Problem : Lamp burns out or makes a popping sound

- ▶ When the lamp reaches its end of life, it will burn out and may make a loud popping sound. If this happens, the projector will not turn on until the lamp module has been replaced. To replace the lamp, follow the procedures in the "Replacing the Lamp". See page 38.

Problem: LED lighting message

Message	Power LED			Temp LED	Lamp LED
	Green	Orange	Red		
Standby State (Input power cord)	○	☀	○	○	○
Normal Mode	☀	○	○	○	○
Cooling	○	Flashing	○	○	○
Error (Lamp failed)	○	○	☀	○	☀
Error (Fan failed)	○	○	☀	Flashing	○
Error (Over Temp.)	○	○	☀	☀	○
Error (Lamp cover failed)	○	○	☀	○	Flashing
Error (Color wheel failed)	○	○	☀	Flashing	Flashing



Steady light => ☀
No light => ○

Appendices (Continued)

Replacing the lamp

The projector will detect the lamp life itself. It will show you a warning message “The Lamp life is ending” When you see this message, change the lamp.

Make sure the projector has been cooled down for at least one hour before changing the lamp.



Warning: Lamp compartment is hot! Allow it to cool down before changing lamp!

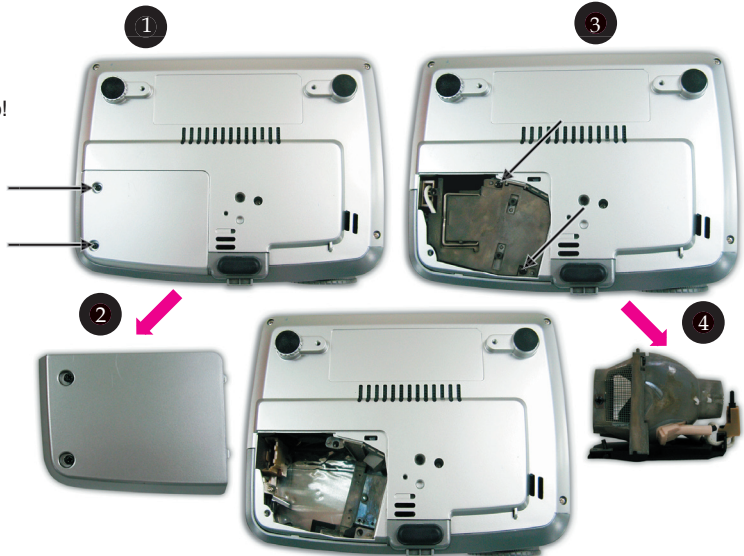

Warning: To reduce the risk of personal injury, do not drop the lamp module or touch the lamp bulb. The bulb may shatter and cause injury if it is dropped.

Used Lamps

This projector's lamps contain trace amounts of environmentally harmful inorganic mercury. Be careful not to break used lamps, and dispose of them in accordance with local regulations.

Lamp Replacing Procedure:



1. Switch off the power to the projector by pressing the Power button twice.
2. Allow the projector to cool down at least 1 hour.
3. Disconnect the power cord.
4. Use a screwdriver to remove the screw from the cover. ❶
5. Push up and remove the cover. ❷
6. Remove the 2 screws from the lamp module. ❸
7. Pull out the lamp module. ❹

To replace the lamp module, reverse the previous steps.

8. Reset the lamp timer.

Appendices (Continued)

Notes and Precautions

- It is recommended that the lamp be replaced after 2,000 hours of use. When [Lamp time] reaches 2,000 hours, the icon  and a message will appear with a beep sound. (After 2,000 hours, they will appear when the power is on at the first time every 100 hours.) This display disappears when you press  button.
- Attach the outer lamp cover correctly so that it is not loose. If it is not attached correctly, the projector may fail to be powered on or the lamp may fail to come on.
- Always replace the lamp with a new one.
- The lamp is made out of glass. Do not touch the glass surface with your bare hands, bang it, or scratch it. (Dirt, jolts, scratches and the like could break the lamp.)

Appendices (Continued)

Computer Compatibility (Analog)

This project supports the following RGB signals. Note, however, that depending on the computer model, the screen may show flicker or streaking. Please adjust the projector if this happens.

(Press the SET UP button, and adjust automatically or manually.)

Resolution	Mode	Refresh rate [Hz]	H-frequency [KHz]	Clock (MHz)
640x350	640x350_70	70	31.5	30
	640x350_85	85.08	37.86	35
640x400	640x400_85	85.08	37.86	35
640x480	VGA_60	59.94	31.46	25.17
	VGA_72	72.8	37.86	31.5
	VGA_75	75	37.5	31.5
	VGA_85	85	43.26	36
720x400	720x400_70	70	31.5	32
	720x400_85	85.03	37.92	35.5
800x600	SVGA_56	56.25	35.15	36
	SVGA_60	60.3	37.87	40
	SVGA_72	72.18	48.07	50
	SVGA_75	75	46.87	49.5
	SVGA_85	85.06	53.67	56.25
1024x768	XGA_60	60	48.36	65
	XGA_70	70.06	56.47	75
	XGA_75	75.02	60.02	78.75
	XGA_85	84.99	68.67	94.5
1280x1024	1280x1024_60	60.02	63.98	108
	1280x1024_75	75.02	79.97	135
1152x864	1152x864_70	70	63.85	90.3
	1152x864_75	75	67.5	108
	1152x864_85	84.99	77.09	130
1280x960	1280x960_60	60	60	108
	1280x960_75	75	75	120
1400x1050	SXGA +	60	63.98	118
832x624	MAC 16"	74.55	49.725	57.28
1024x768	MAC 19"	75	60.24	79.85
1152x870	MAC	75.06	68.68	81
640x480	MAC G4	60	31.35	40
1024x768	i Mac DV	75	60	79
1152x870	i Mac DV	75	68.49	80.05
1280x960	i Mac DV	75	75	120



Remark :

- 1.> "*"compressed computer image.
- 2.> The interlaced analog signals are not supported.

Note

Signals which resolution exceeds the native resolution (1024x768 pixels) will be compressed. For this reason, some information will be lost, or image quality may be affected.

Appendices (Continued)

Specifications

List of general specifications

Consumption Power	- 195W
Weight	- 1.0Kg
External Dimensions	- 200 x 75.3 x 154.2 mm (WxHxD)
Cabinet material	- AL & MG alloy + PC + ABS resin
Conditions for usage environment	- Temp : 5 °C to 35 °C Relative humidity : 30% to 70%
Display pixels	- 1 Chip DMD™
Picture elements	- 786,432 pix els (1024H x 768V)
Lens	- Zoom lens F= 2.7-2.88 f = 28.43 - 32.73 mm
Lamp	- High - pressure mercury lamp
Projection screen size	- 31.7- 300 inches
Projection distance	- 1.5m – 12.2m

Connection terminal

Computer Input (VGA)	- Mini D sub 15 pin RGB/Y/P _B / P _R (Dual use)
Video Input (x 1)	- RCA Pin Jack
S Video Input (Standard x 1)	- Mini DIN 4 pin
USB Port	- For mouse remote control

■ Notes

- This model complies with the above specification
- Designs and specification are subject to change without notice.
- This model may not be compatible with features and/or specifications that maybe added in the future.

About Lamp

About Lamp

The product's light source is a mercury lamp that lights at increased internal pressure. Be sure to fully understand the following characteristics of the lamp and handle it with extreme care.

- The lamp may burst with a loud noise due to impact or deterioration, or fail to light at the expiration of its life.
- How long it takes before the lamp bursts or the life expires may vary greatly by lamp.
Some may burst shortly after first use.
- Burst is likely to happen if the lamp is used after the replacement period has elapsed.
- When the lamp bursts, the broken pieces of glass may get inside the product or be released outside from the openings for ventilation.
- When the lamp bursts, a slight amount of mercury gas enclosed in the lamp along with glass dust may be released from the openings for ventilation.

Immediately replace the lamp when a sign appears on the screen.

- When the replacement time approaches, a message will appear on the screen.
- The risk of burst will increase if the lamp is continuously used without being replaced.
- Frequently check the used hours and prepare spares when the replacement time approaches.

When the lamp is broken

- If glass components, including a lamp and a lens, should break, handle the broken pieces with care to avoid injury and contact your dealer for repair service.
- In the event of lamp burst, unplug the product from the wall outlet, leave and completely ventilate the room. Then, thoroughly clean the area around the projector and discard any edible items placed in that area.
- When the lamp bursts, consult a doctor if glass dust or mercury gas gets into your eyes or you breathe it.

About Lamp

Lamp replacement

A lamp is consumable supplies. If used for extended periods, images will appear dark, and the lamp could burn out. This is characteristic of a lamp, and is not malfunction. (The lifetime of the lamp depends on condition of use.) If this happens, replace it with a new one.



CAUTION

If you have been using the projector, the lamp will be very hot, and may cause burn injuries.

Wait for the lamp to cool (for longer than 1 hour) before replacing it.

If the lamp should break, please handle with care to avoid injury due to broken pieces and contact your dealer for repair service.

Lens cleaning

- Clean the lens with a commercially available blower and/or lens cleaner.
- The lens is easily scratched, so do not rub it with hard objects, or strike it.

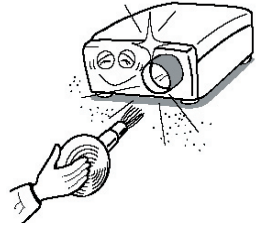

Main unit cleaning

- Clean the main unit after unplugging the power cord.
- Wipe dirt off the main unit gently with a soft cloth.
- Do not wipe the main unit with a damp cloth. Doing so may allow water to get inside, resulting in an electric shock or failure.
- Do not use benzene, thinner and the like as they may deform or discolor the unit or damage the paint surface.
- When using a chemically treated cloth, follow the precautions included with the cloth.

